

FEATURES

- High resistant to electrostatic noise by using a plastic shaft
- Compact size of 16 mm square
- With mechanical ON/OFF push switch
- Long life
- RoHS compliant

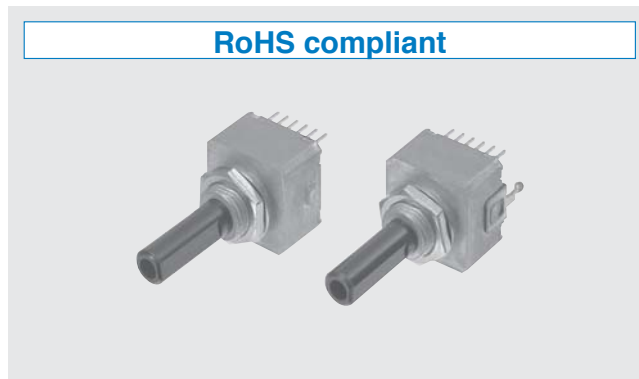

PART NUMBER DESIGNATION

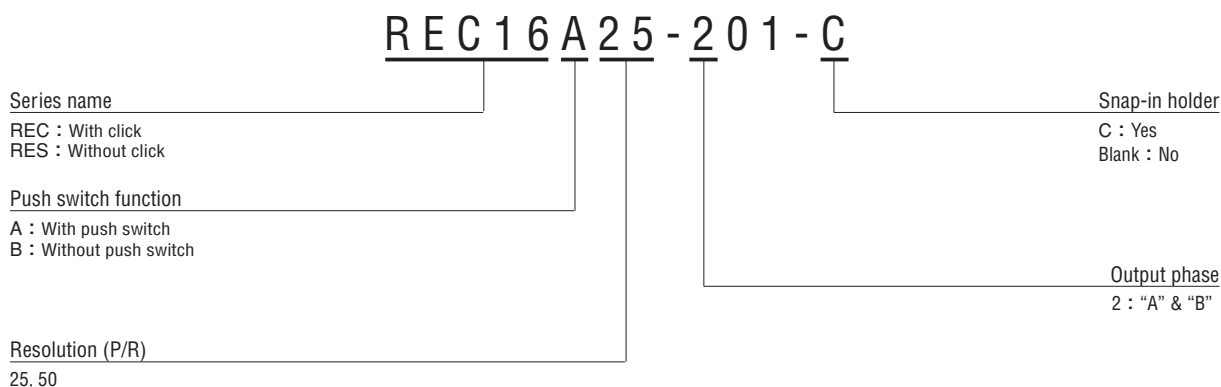

LIST OF PART NUMBERS

Resolution \ Test item	Click	Push switch function	Snap-in holder	Part number
25 (P/R)	With Click	Yes	No	REC16A25-201
			Yes	REC16A25-201-C
	Without Click	No	No	REC16B25-201
			Yes	REC16B25-201-C
			No	RES16B25-201
			Yes	RES16B25-201-C
50 (P/R)	With Click	Yes	No	REC16A50-201
			Yes	REC16A50-201-C
	Without Click	No	No	REC16B50-201
			Yes	REC16B50-201-C
			No	RES16B50-201
			Yes	RES16B50-201-C

REC16/RES16

OPTICAL ENCODERS

STANDARD SPECIFICATIONS

Electrical characteristics

Input voltage	DC5 V \pm 5 %	
Input current	30 mA maximum	
Output wave form	Square wave	
Output phases	A, B	
(P/R) Resolution	25, 50	
Phase difference of outputs A & B	$90^\circ \pm 45^\circ$	
Maximum frequency response	100 Hz	
Output signal	"1 (High)"	+ 4.5 V minimum
	"0 (Low)"	+ 0.5 V maximum
Light source	LED	

Switch characteristics

Maximum contact rating	DC15 V, 20 mA
Contact resistance	200 m Ω maximum (Initial value)

Note) Manual setting only.

Mechanical characteristics

Starting torque	1.18 mN·m \pm 0.78 maximum (12 \pm 8 gf·cm) <RES: Without click>	
Click torque	6.87 mN·m \pm 3.43 maximum (70 \pm 35 gf·cm) <REC: With click>	
Click number	25, 50	
Shaft loading (Pull-push)	19.6 N maximum (2 kgf)	
Switch operation force	7.85 N \pm 2.94 N (800 \pm 300 gf)	
Switch stroke	0.5 mm	
Rotational life (Mechanical)	1 million cycles	
Switching life	1 million cycles	
Shaft loading (When mounting)	Radial	4.90 N maximum (500 gf)
	Axial	2.94 N maximum (300 gf)
Net weight	Approx. 10 g	
Strength of tighten screw	1 N·m {10.2 kgf·cm} maximum	

Environmental characteristics

Operating temp. range	0 ~ 50 °C
Storage temp. range	- 20 ~ 80 °C
Protection grade	IP40

OUTPUT

Click spot for 25P/R

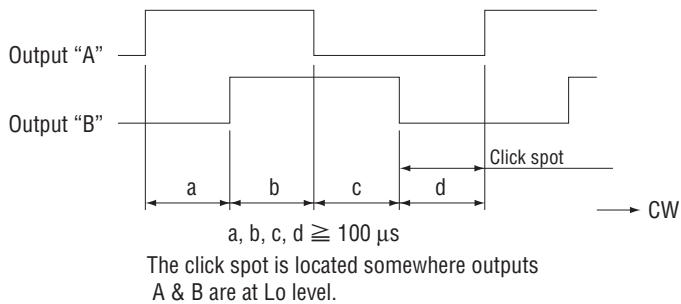

Click spot for 50P/R

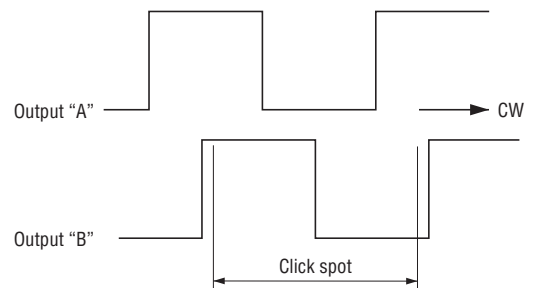

RELIABILITY TEST

The output shall satisfy the criteria below after the following tests.

Test item		Test conditions	
Vibration	Power OFF	Amplitude : 1.52 mm or 98.1 m/s ² (10 G) whichever is smaller. 10 ~ 500 Hz excursion 15 min/cycle, 8 cycles each for X, Z, directions.	
Shock	Power OFF	3 times each in directions (X, Z) at 490 m/s ² (50 G), 11 ms.	
High temperature exposure	Power OFF	80 °C 96 h	(To be measured after leaving samples for 1 h at normal temperature and humidity after the test.)
	Power ON	50 °C 96 h	
Low temperature exposure	Power OFF	- 20 °C 96 h	
	Power ON	0 °C 96 h	
Humidity	Power OFF	40 °C Relative humidity 90 ~ 95 % 96 h (To be measured after wiping out moisture and leaving samples for 1 h at normal temperature and humidity after the test.)	
Thermal shock	Power OFF	To be done 10 cycles with the following condition (To be measured after leaving samples for 1 h at normal temperature and humidity after the test.) 80 °C 0.5 h、- 20 °C 0.5 h	

OUTLINE DIMENSIONS

Unless otherwise specified, tolerance: ± 0.4 (Unit: mm)

Without snap-in holder

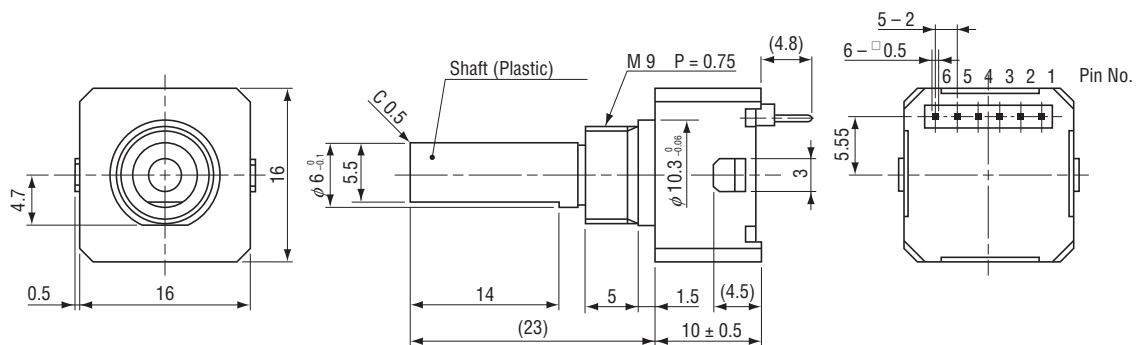

※ Connector : Made by Hirose Electric Co., Ltd.
A4B-6PA-2DSA

REC16/RES16

OPTICAL ENCODERS

OUTLINE DIMENSIONS

With snap-in holder

Unless otherwise specified, tolerance: ± 0.4 (Unit: mm)

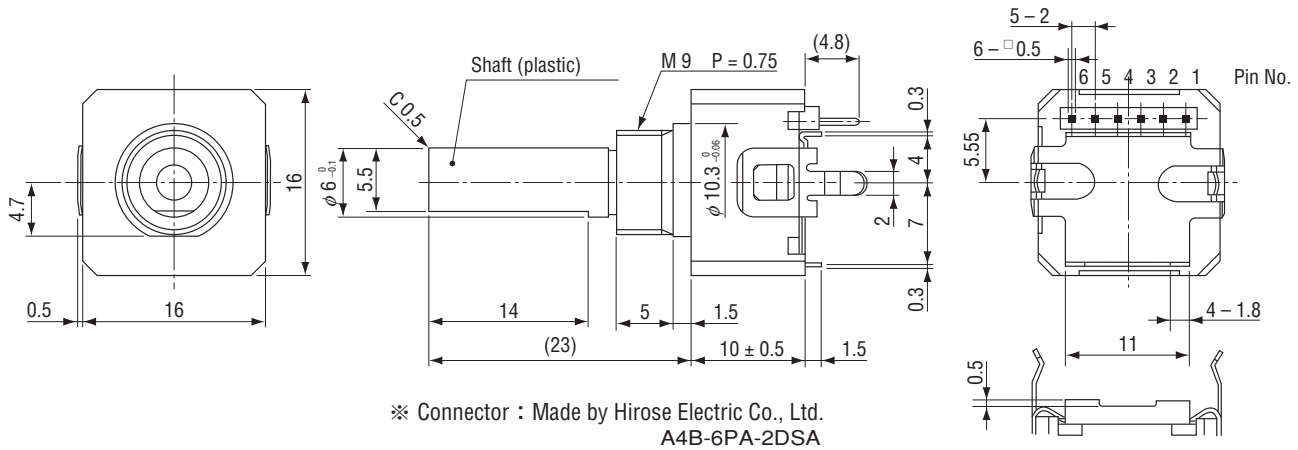

Accessories

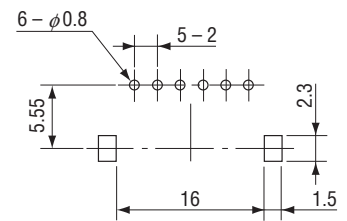
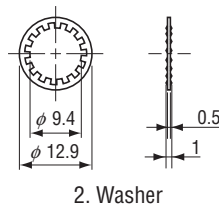
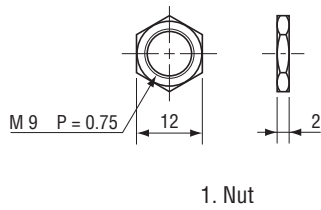

Mounting hole dimension (Tolerance: ± 0.1)
(Board thickness $t = 1.6$)

PIN ASSIGNMENT

Pin No.	With switch	Without switch
1	Power 0 (V)	Power 0 (V)
2	Output "B"	Output "B"
3	For switch	N C
4	For switch	N C
5	Power \oplus	Power \oplus
6	Output "A"	Output "A"

OUTPUT CIRCUIT

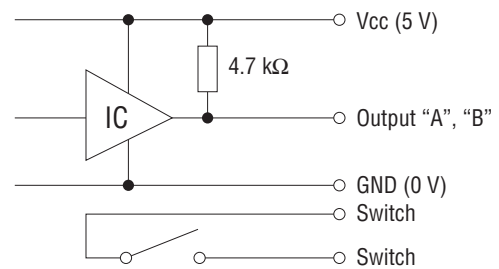

KNOB FOR SETTING ENCODERS

The knobs are sold separately as an optional item. (Ref. P. 310)