

Types MCH and MCHN Multilayer High RF Power Capacitors

2500 & 4000 Volt RF Capacitors for Medical Imaging Coils, Plasma Generators, VHF/UHF Power Amplifiers and Antenna Tuning with Nonmagnetic Option

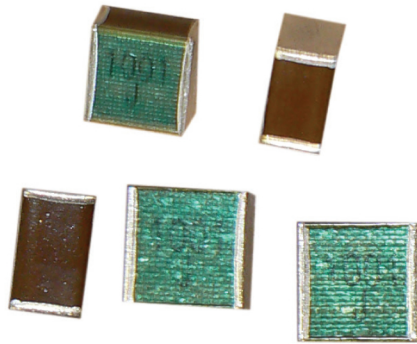

The flexible aluminum silicate dielectric eliminates cracking and permits soldering to 260 °C. These high voltage, RF capacitors need no voltage derating at temperatures up to 125 °C and voltages to 4000 Vdc. Exceptionally low ESR and superior thermal qualities set the MCH/MCHN chip capacitors apart from ordinary RF capacitors.

Highlights

- No thermal cracking
- FR4 compatible and wave solderable
- Extremely high Q above 50 MHz
- Nonmagnetic option available
- Ultra stable: no change with (t), (V) and (f)
- Excellent for tuning and impedance matching
- High flashover level
- Withstands 2 mm bend test
- Better than porcelain

Applications

- MRI Coils
- RF Ablation Systems
- Transmitters
- RF Generators
- Antenna Tuning
- Lasers
- RF Power Amplifiers
- MRI Generators

Specifications

RoHS Compliant

Capacitance and Voltage Ratings:

10 – 220 pF at 4kVdc and 270 – 1000 pF at 2500 Vdc (other ratings available)

Capacitance Tolerance:

±5% standard (±2% available)

Temperature Range:

–55 °C to +125 °C (with no voltage derating)

Case Size:

3838 (9.7 x 9.7 mm)

Temperature Characteristics:

Temp. Coefficient	Cap Drift
0 to +50 ppm/°C	±(0.05%+0.1 pF)

Engineering Design Kits

MCH2500VKIT8, MCH4000VKIT10

Nonmagnetic MCHN2500VKIT9, MCHN4000VKIT11

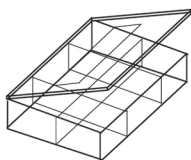

2500 V kits 5 each of 8 values 270 to 1000 pF

4000 V kits 5 each of 10 values 10 – 220 pF

High Q, Low ESR Multilayer Construction for RF Power Applications

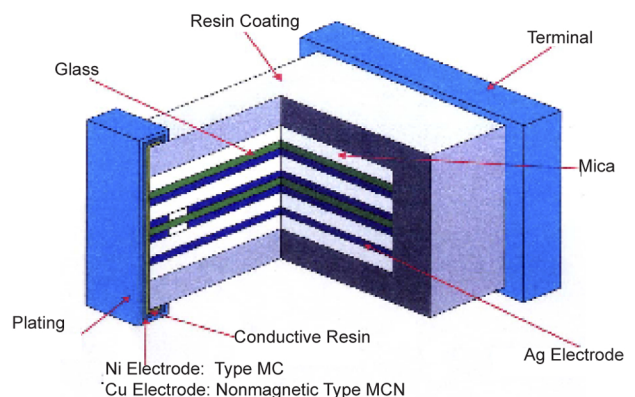

Types MCH and MCHN Multilayer High RF Power Capacitors

Outline Drawing

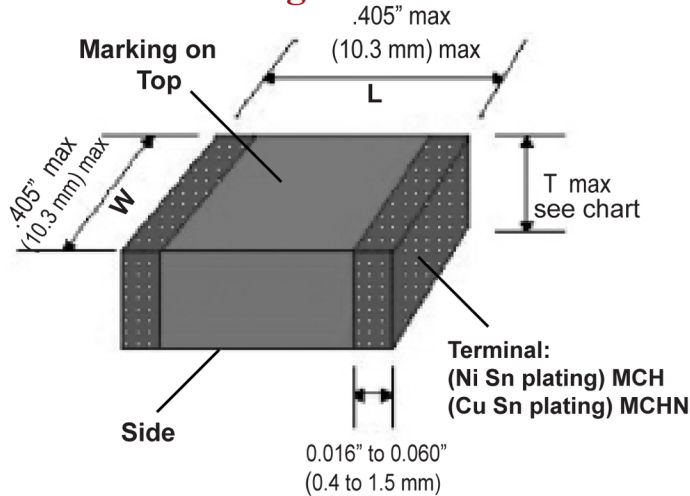

Soldering Pattern

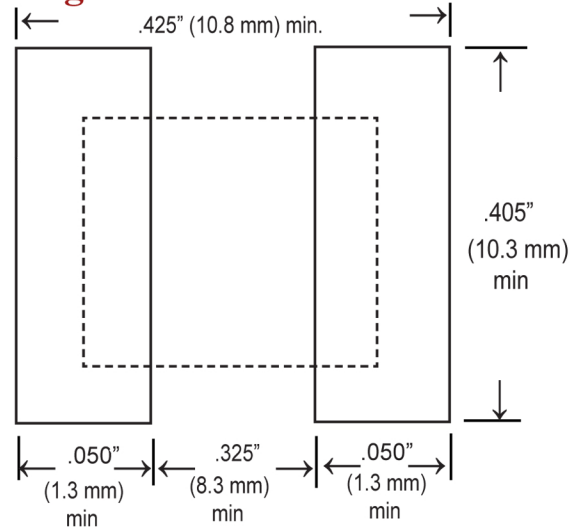

Part Numbering System

MCH	38	F	K	271	J	-Y
Type	Case Code	Temperature Coefficient	Voltage	Capacitance	Tolerance	Package
MCH = Standard MCHN = Nonmagnetic	38 = .380x.380	F=0 to +50 ppm/°C	K = 2500 Vdc M=4000 Vdc	100 = 10 pF 271 = 270 pF 102 = 1000 pF	J = ±5% G = ±2% D = ± 0.5 pF	Blank = Bulk (100 per bag) -Y = Tray pack (100 per tray)

Ratings (additional ratings available)

RoHS Compliant

Cap (pF)	Catalog Part Number*	Voltage (Vdc)	Length Inches (mm)	Width Inches (mm)	T max Inches (mm)
10	MCH38FM100D-Y	4000 Vdc	0.380 +0.025 / -0 (9.65 mm +0.65 / -0)	0.380 +0.025 / -0 (9.65 mm +0.65 / -0)	0.080 (2.03 mm)
12	MCH38FM120J-Y				
15	MCH38FM150J-Y				
18	MCH38FM180J-Y				
22	MCH38FM220J-Y				
27	MCH38FM270J-Y				
33	MCH38FM330J-Y				
39	MCH38FM390J-Y				
47	MCH38FM470J-Y				
56	MCH38FM560J-Y				
68	MCH38FM680J-Y				
82	MCH38FM820J-Y				
100	MCH38FM101J-Y				
120	MCH38FM121J-Y				
150	MCH38FM151J-Y				
180	MCH38FM181J-Y				
220	MCH38FM221J-Y				
270	MCH38FK271J-Y	2500 Vdc			0.160 (4.06 mm)
330	MCH38FK331J-Y				
390	MCH38FK391J-Y				
470	MCH38FK471J-Y				
560	MCH38FK561J-Y				
680	MCH38FK681J-Y				
820	MCH38FK821J-Y				
1000	MCH38FK102J-Y				

*For nonmagnetic version change P/N prefix to MCHN

Types MCH and MCHN Multilayer High RF Power Capacitors

Typical Performance Data

ESR vs. Frequency for 470 pF

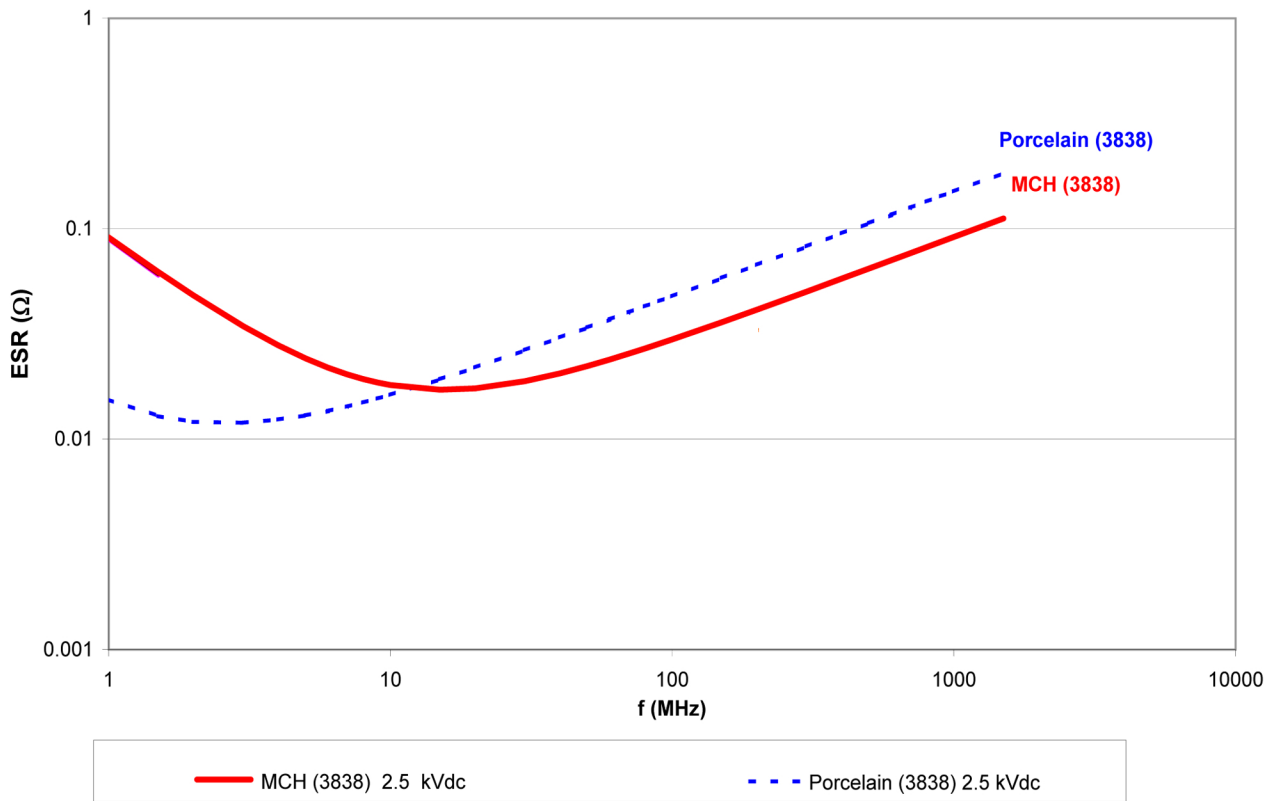

Current Rating (IRMS) for 470 pF at 60 °C Rise

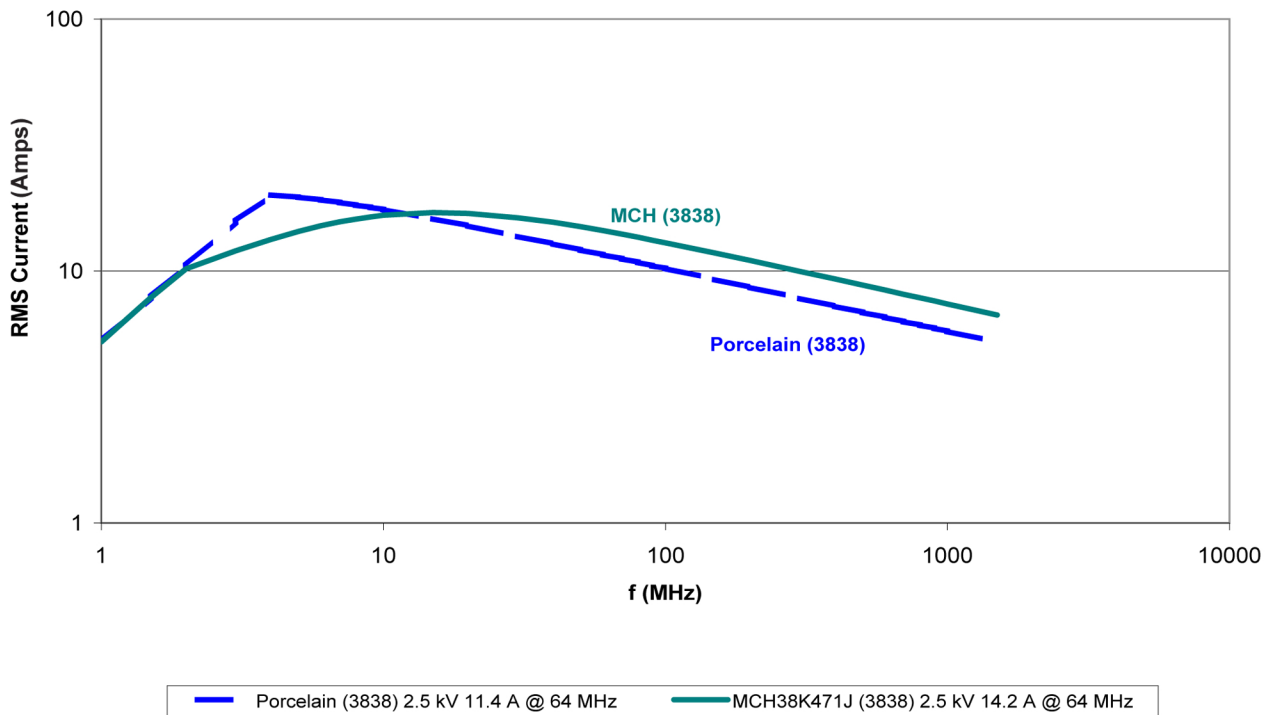

Types MCH and MCHN Multilayer High RF Power Capacitors

Typical Performance Data

Q vs. Frequency 470 pF @ 25 °C

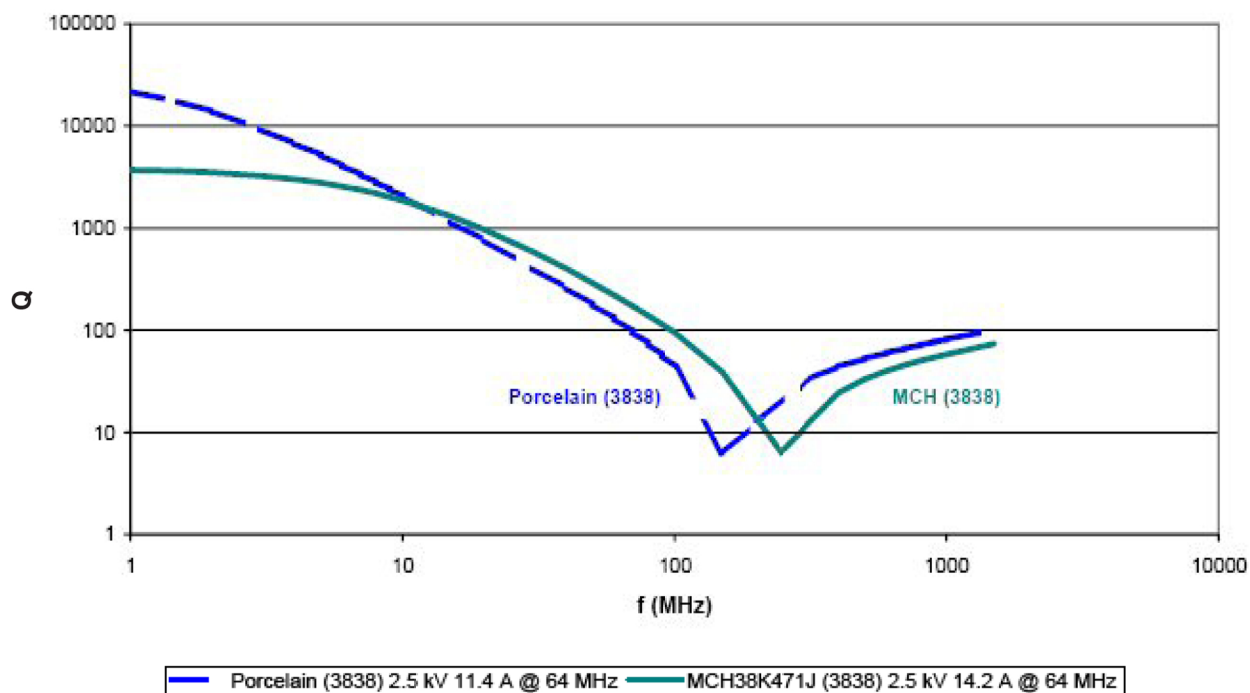

Impedance vs. Frequency for 470 pF @ 25 °C

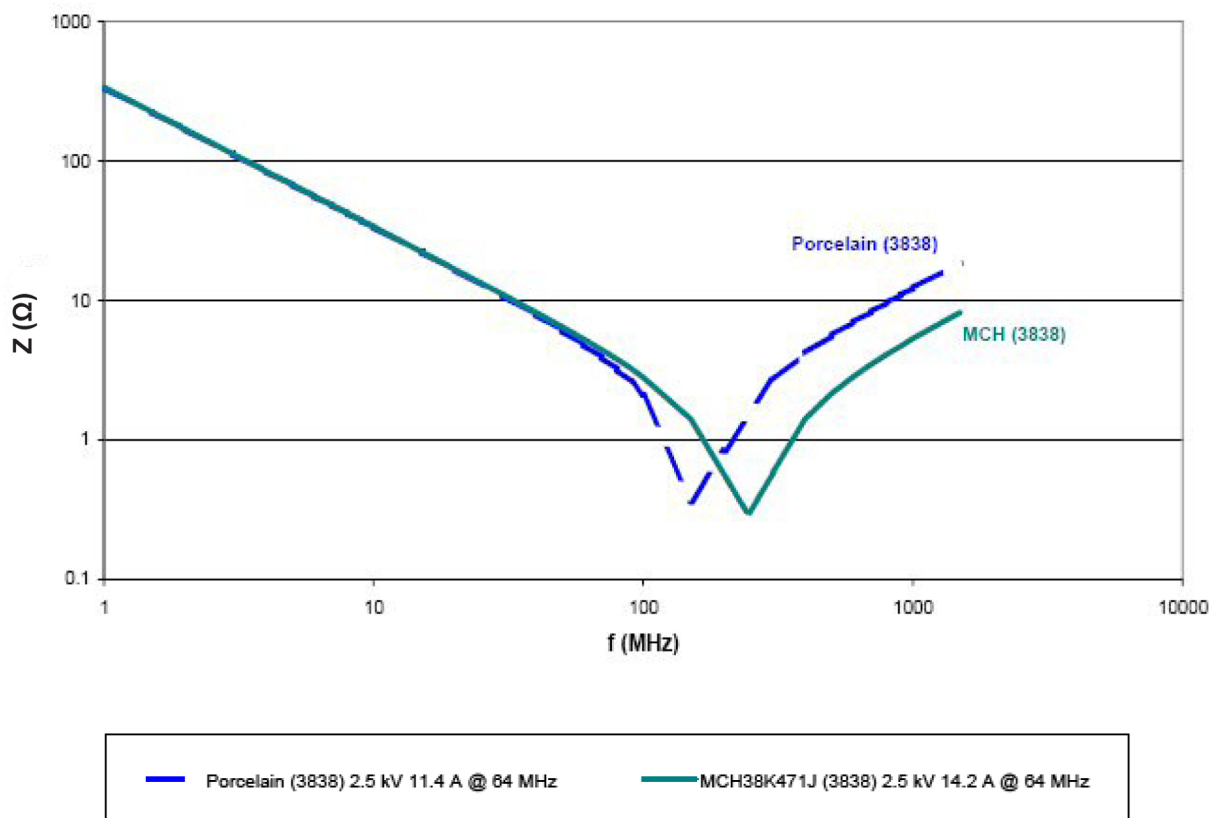

Types MCH and MCHN Multilayer High RF Power Capacitors

Typical Performance Data

MCH vs. Porcelain (3838) Breakdown Voltage (BDV)

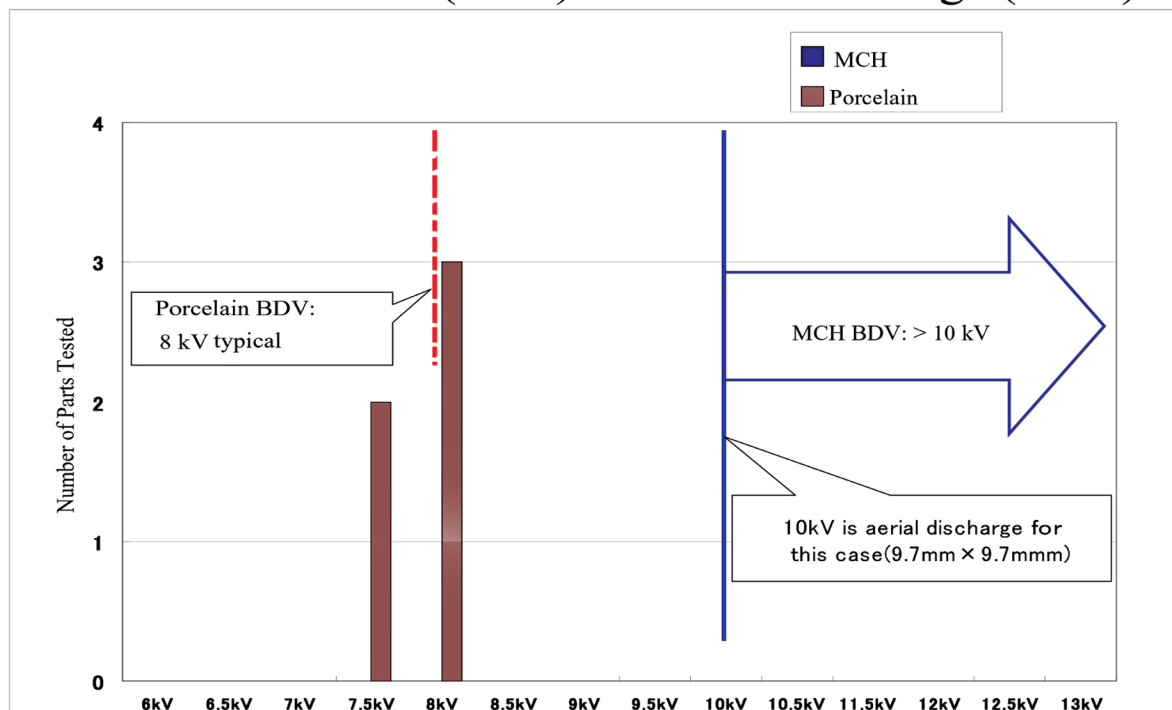

Environmental Specifications

Humidity (No Load): +40 °C ±2 °C @ 90% to 95% RH, 500 hrs. Measure after 24 hrs, cap is ±3% of initial, DF ≤150% of original, IR 3x10⁴ MΩ, no visual damage

Storage Method: Store at 0 to +40 °C at ≤60% RH, use within 6 months of receipt, if 6 months is exceeded, check solderability

Electrical Specifications

Dielectric Strength: 2500 Vdc: 1.5 x Rated Voltage for 5 seconds
4000 Vdc: 1.2 x Rated Voltage for 5 seconds

Dissipation Factor (DF): ≤0.1% @ 1 MHz and ≤5 Vrms

Insulation Resistance: 100K MΩ minimum @ 500 Vdc ±10%

Types MCH and MCHN Multilayer High RF Power Capacitors

Mechanical Specifications

Bending Test:

Mount the capacitor as shown below and press the ram bar until a 2.0 mm deflection is achieved. There will be no visual damage and the capacitors will meet the limits of methods JIS 5102 8.11 and AEC-Q200-005 without cracking or visual damage.

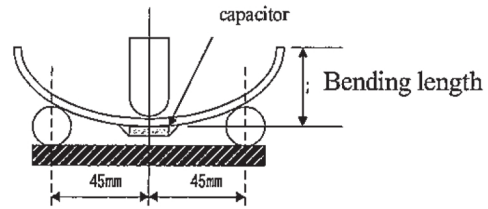

Soldering Specifications

Reflow Solder Profile

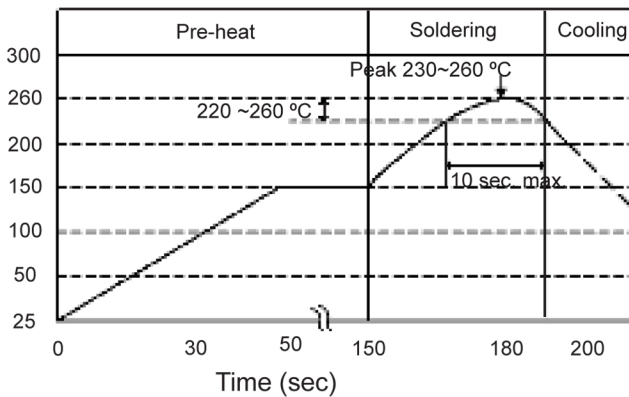

Wave Solder Profile

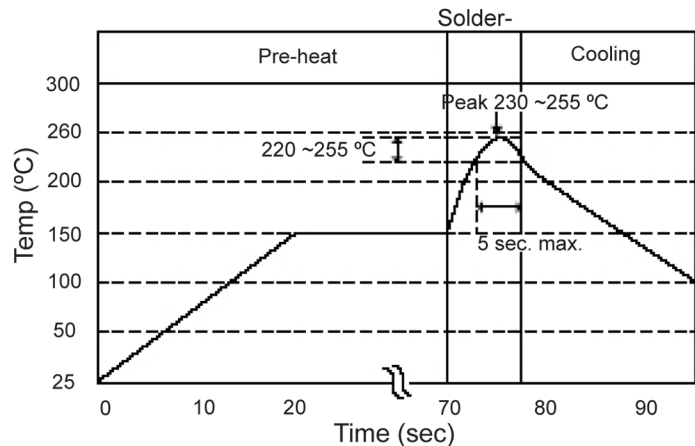

Hand Soldering Method

- SnPb or SnAgCu recommended solder
- Do not use strong acid type flux with RM or RMS
- Soldering iron tip temperature should be 280 °C to 350 °C ≤ 5 sec.
- 80 Watt iron or less
- Iron tip should not touch chip terminals

